

ATC 800 E Series NPO Ceramic High RF Power Multilayer Capacitors

- Case E Size (.380" x .380")
- High Q
- Ultra Low ESR
- High RF Power
- 7200 WVDC
- Capacitance Range: 3.3 pF to 5100 pF
- Ultra-Stable Performance
- High RF Current/Voltage
- High Reliability
- RoHS Compliant, Pb free

ATC's 800 E Series offers superb performance in demanding high RF power applications requiring consistent and reliable operation. The combination of highly conductive metal electrode systems, optimized case geometries, and proprietary dielectrics, yields the lowest ESR. ATC's new NPO low loss rugged dielectrics are designed to provide superior heat transfer in high RF power applications. Ultra-low ESR and superior thermal performance insure that the 800 E Series products are your best choice for high RF power applications from VHF through microwave frequencies.

Typical functional applications: Bypass, Coupling, Tuning, Impedance Matching and DC Blocking

Typical circuit applications: HF/RF Power Amplifiers, Transmitters, Antenna Tuning, Plasma Chambers and Medical (MRI coils).

ENVIRONMENTAL TESTS

ATC 800 E Series Capacitors are designed and manufactured to meet and exceed the requirements of EIA-198, MIL-PRF-55681 and MIL-PRF-123.

THERMAL SHOCK:

MIL-STD-202, Method 107, Condition A

MOISTURE RESISTANCE:

MIL-STD-202, Method 106

LOW VOLTAGE HUMIDITY:

MIL-STD-202, Method 103, Condition A, with 1.5 Volts DC applied while subjected to an environment of 85°C with 85% relative humidity for 240 hours min.

LIFE TEST:

MIL-STD-202, Method 108, for 2000 hours, at 125°C.

Voltage applied.

120% of WVDC for capacitors rated at 1250 volts DC or less.

100% of WVDC for capacitors rated above 1250 volts DC

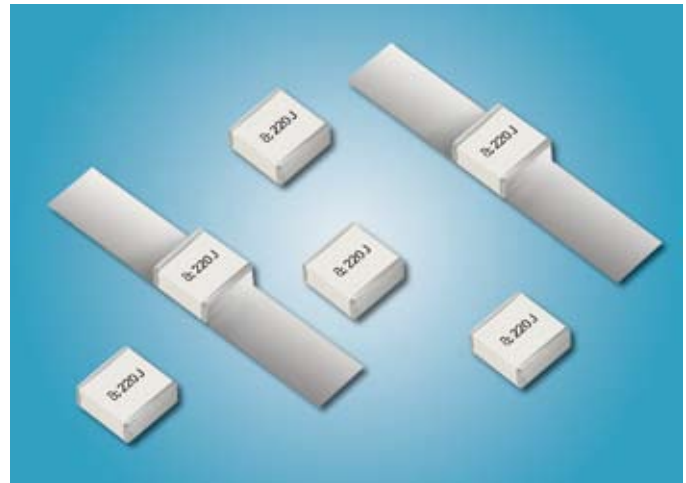

ELECTRICAL AND MECHANICAL SPECIFICATIONS

QUALITY FACTOR (Q):

Greater than 5,000 (3.3 pF to 1000 pF) @ 1 MHz.

Greater than 5,000 (1100 pF to 5100 pF) @ 1 KHz.

TEMPERATURE COEFFICIENT OF CAPACITANCE (TCC):

0 ±30 PPM/°C (-55°C to +125°C)

INSULATION RESISTANCE (IR):

10⁵ Megohms min. @ +25°C at rated WVDC

10⁴ Megohms min. @ +125°C at rated WVDC

WORKING VOLTAGE (WVDC):

See Capacitance Values Table, page 2

DIELECTRIC WITHSTANDING VOLTAGE (DWV):

150% of WVDC for capacitors rated above 500 volts DC and ≤1250 volts DC for 5 seconds.

120% of WVDC for capacitors rated above 1250 volts DC for 5 seconds..

RETRACE: Less than ±(0.02% or 0.02 pF), whichever is greater

AGING EFFECTS: None

PIEZOELECTRIC EFFECTS: None

(No capacitance variation with voltage or pressure)

CAPACITANCE DRIFT: ±(0.02% or 0.02 pF), whichever is greater

OPERATING TEMPERATURE RANGE:

From -55°C to +125°C

TERMINATION STYLE:

See Mechanical Configurations, page 3

TERMINAL STRENGTH: Terminations for chips withstand a pull of 10 lbs. min., 25 lbs. typical, for 5 seconds in direction perpendicular to the termination surface of the capacitor. Test per MIL-STD-202, method 211.



AMERICAN TECHNICAL CERAMICS

ATC North America
631-622-4700
sales@atceramics.com

ATC Europe
+46 8 6800410
sales@atceramics-europe.com

ATC Asia
+86-755-2396-8759
sales@atceramics-asia.com



www.atceramics.com

ATC # 001-1077 Rev. G, 1/12

ATC 800 E Capacitance Values

CAP. CODE	CAP. (pF)	TOL.	RATED WVDC	CAP. CODE	CAP. (pF)	TOL.	RATED WVDC	CAP. CODE	CAP. (pF)	TOL.	RATED WVDC
3R3	3.3	B, C, D	7200	360	36	F, G, J, K	7200	391	390	F, G, J, K	2500
3R6	3.6			390	39			431	430		
3R9	3.9			430	43			471	470		
4R3	4.3			470	47			511	510		
4R7	4.7			510	51			561	560		
5R1	5.1			560	56			621	620		
5R6	5.6			620	62			681	680		
6R2	6.2			680	68			751	750		
6R8	6.8			750	75			821	820		
7R5	7.5			820	82			911	910		
8R2	8.2	910	91	102	1000	F, G, J, K	3600	112	1100	F, G, J, K	1500
9R1	9.1	101	100	122	1200						
100	10	121	120	132	1300						
110	11	131	130	152	1500						
120	12	151	150	162	1600						
130	13	161	160	182	1800						
150	15	181	180	202	2000						
160	16	201	200	222	2200						
180	18	221	220	242	2400						
200	20	241	240	272	2700						
220	22	271	270	302	3000	G, J, K	2500	332	3300	G, J, K	1000
240	24	301	300	332	3300						
270	27	331	330	392	3900						
300	30	361	360	472	4700						
330	33			512	5100						

CAPACITANCE TOLERANCE							
Code	B	C	D	F	G	J	K
Tol.	±0.1 pF	±0.25 pF	±0.5 pF	±1%	±2%	±5%	±10%

ATC PART NUMBER CODE

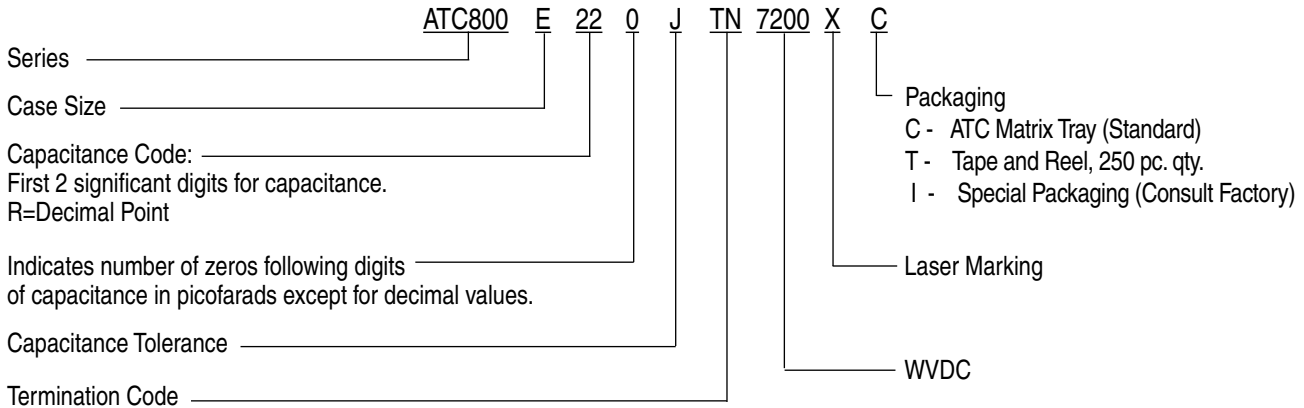

The above part number refers to a 800 E Series (case size E) 22 pF capacitor, J tolerance (±5%), 7200 WVDC, with TN termination (Tin Plated over Non-Magnetic Barrier Termination), laser marking and plastic Matrix Tray packaging.

ATC accepts orders for our parts using designations **with** or **without** the "ATC" prefix. Both methods of defining the part number are equivalent, i.e., part numbers referenced with the "ATC" prefix are interchangeable to parts referenced without the "ATC" prefix. Customers are free to use either in specifying or procuring parts from American Technical Ceramics.

For additional information and catalogs contact your ATC representative or call direct at (631) 622-4700.

Consult factory for additional performance data.

ATC 800 E Capacitors: Mechanical Configurations

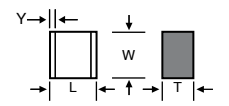
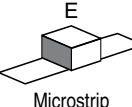
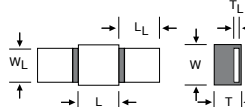
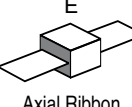
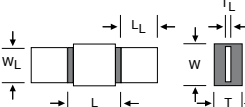
ATC SERIES & CASE SIZE	ATC TERM. CODE	CASE SIZE & TYPECASE SIZE & TYPE	OUTLINES W/T IS A TERMINATION SURFACE	BODY DIMENSIONS INCHES (mm)			LEAD AND TERMINATION DIMENSIONS AND MATERIALS	
				LENGTH (L)	WIDTH (W)	THICKNESS (T)	OVERLAP (Y)	MATERIALS
800 E	T	 E Solderable Nickel Barrier		.380 +0.015 -.010 (9.65 +0.38 -0.25)	.380 +0.015 -.010 (9.65 +0.38 -0.25)	.190 (4.83) max.	.040 (1.02) max.	RoHS Compliant Tin Plated over Nickel Barrier Termination
800 E	MS	 E Microstrip		.380 +0.035 -.010 (9.65 +0.89 -0.25)			N/A.	High Purity Silver Leads $L_L = .750$ (19.05) min. $W_L = .350 \pm 0.010$ (8.89 ±0.25) $T_L = .010 \pm 0.005$ (0.25 ±0.13) Leads are Attached with High Temperature Solder
800 E	AR	 E Axial Ribbon						

ATC 800 E Non-Magnetic Capacitors: Mechanical Configurations

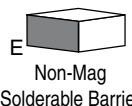
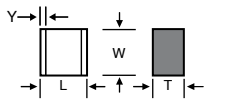
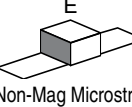
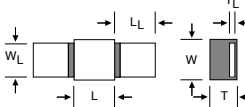
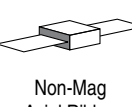
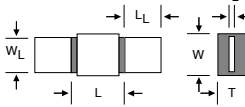
ATC SERIES & CASE SIZE	ATC TERM. CODE	CASE SIZE & TYPECASE SIZE & TYPE	OUTLINES W/T IS A TERMINATION SURFACE	BODY DIMENSIONS INCHES (mm)			LEAD AND TERMINATION DIMENSIONS AND MATERIALS	
				LENGTH (L)	WIDTH (W)	THICKNESS (T)	OVERLAP (Y)	MATERIALS
800 E	TN	 E Non-Mag Solderable Barrier		.380 +0.015 -.010 (9.65 +0.38 -0.25)	.380 +0.015 -.010 (9.65 +0.38 -0.25)	.190 (4.83) max.	.040 (1.02) max.	RoHS Compliant Tin Plated over Non-Magnetic Barrier Termination
800 E	MN	 E Non-Mag Microstrip		.380 +0.035 -.010 (9.65 +0.89 -0.25)			N/A.	High Purity Silver Leads $L_L = .750$ (19.05) min. $W_L = .350 \pm 0.010$ (8.89 ±0.25) $T_L = .010 \pm 0.005$ (0.25 ±0.13) Leads are Attached with High Temperature Solder.
800 E	AN	 E Non-Mag Axial Ribbon						

Custom lead styles and lengths are available; consult factory. All leads are high purity silver attached with high temperature solder and are **RoHS** compliant.

ATC 800 E Capacitors: Suggested Mounting Pad Dimensions

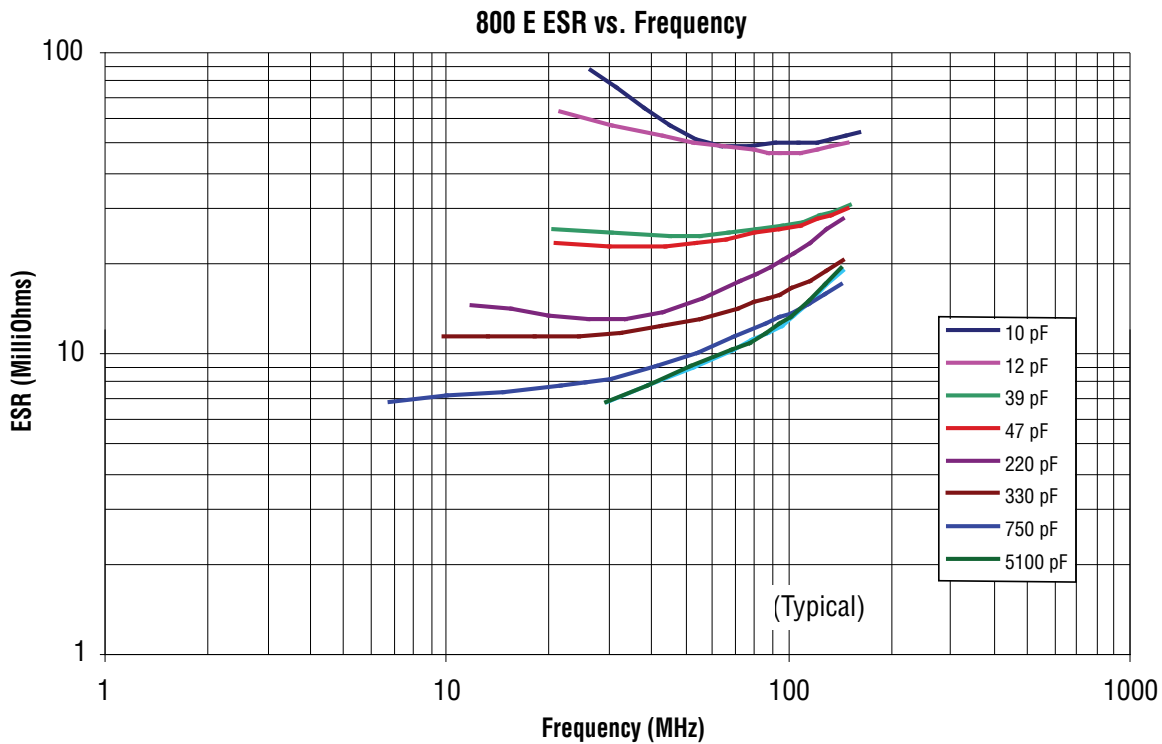
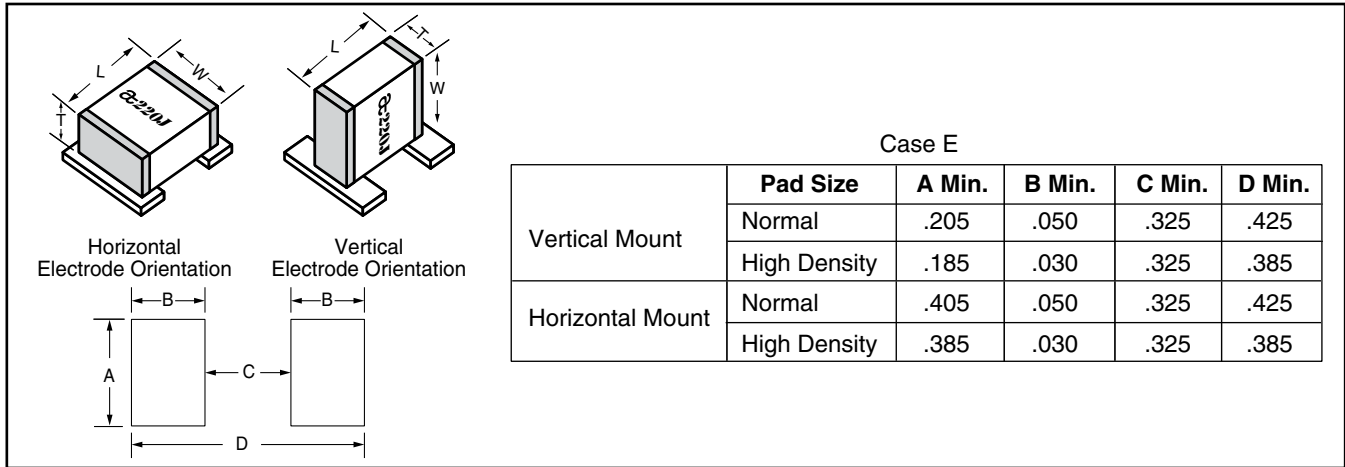

Sales of ATC products are subject to the terms and conditions contained in American Technical Ceramics Corp. Terms and Conditions of Sale (ATC document #001-992 Rev. B; 12/05). Copies of these terms and conditions will be provided upon request. They may also be viewed on ATC's website at www.atceramics.com/productfinder/default.asp. Click on the link for Terms and Conditions of Sale.

ATC has made every effort to have this information as accurate as possible. However, no responsibility is assumed by ATC for its use, nor for any infringements of rights of third parties which may result from its use. ATC reserves the right to revise the content or modify its product without prior notice.

© 2010 American Technical Ceramics Corp. All Rights Reserved

ATC # 001-1077 Rev. G, 1/12

A M E R I C A N T E C H N I C A L C E R A M I C S

ATC North America **ATC Europe** **ATC Asia**
 631-622-4700 • sales@atceramics.com +46 8 6830410 • sales@atceramics-europe.com 86-755-2396-8759 • sales@atceramics-asia.com

www.atceramics.com