

LM78L00 Series 3-Terminal Positive Voltage Regulators

General Description

The LM78L00 series of 3-terminal positive voltage regulators employ internal current-limiting and thermal shutdown, making them essentially indestructible. If adequate heat sinking is provided, they can deliver up to 100 mA output current. They are intended as fixed voltage regulators in a wide range of applications including local (on-card) regulation for elimination of noise and distribution problems associated with single-point regulation. In addition, they can be used with power pass elements to make high current voltage regulators. The LM78L00, used as a Zener diode/resistor combination replacement, offers an effective output impedance improvement of typically two orders of magnitude, along with lower quiescent current and lower noise.

Features

- Output current up to 100 mA
- No external components
- Internal thermal overload protection
- Internal short circuit current-limiting
- Available in JEDEC TO-92
- Output Voltages of 5.0V, 6.2V, 8.2V, 9.0V, 12V, 15V
- Output voltage tolerances of $\pm 5\%$ over the temperature range

Connection Diagram

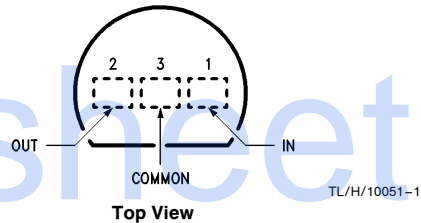

Order Number LM78L05ACZ, LM78L09ACZ,
LM78L12ACZ, LM78L15ACZ, LM78L62ACZ or LM78L82ACZ
See NS Package Number Z03A

Absolute Maximum Ratings

If Military/Aerospace specified devices are required, please contact the National Semiconductor Sales Office/Distributors for availability and specifications.

Storage Temperature Range -65°C to $+150^{\circ}\text{C}$
 Operation Junction Temperature Range
 Commercial (LM78L00AC) 0°C to $+125^{\circ}\text{C}$

Lead Temperature
 TO-92 Package/SO-8
 (Soldering, 10 sec.)

265°C

Power Dissipation

Internally Limited

Input Voltage

35V

5.0V to 15V

ESD Susceptibility

to be determined

LM78L05AC

Electrical Characteristics

$0^{\circ}\text{C} \leq T_A \leq +125^{\circ}\text{C}$, $V_I = 10\text{V}$, $I_O = 40\text{ mA}$, $C_I = 0.33\ \mu\text{F}$, $C_O = 0.1\ \mu\text{F}$, unless otherwise specified (Note 1)

Symbol	Parameter	Conditions	Min	Typ	Max	Units
V_O	Output Voltage	$T_J = 25^{\circ}\text{C}$	4.8	5.0	5.2	V
$V_{R\text{ LINE}}$	Line Regulation	$T_J = 25^{\circ}\text{C}$		55	150	mV
		$7.0\text{V} \leq V_I \leq 20\text{V}$		45	100	
$V_{R\text{ LOAD}}$	Load Regulation	$T_J = 25^{\circ}\text{C}$		11	60	mV
		$1.0\text{ mA} \leq I_O \leq 100\text{V}$		5.0	30	
V_O	Output Voltage (Note 2)	$7.0\text{V} \leq V_I \leq 20\text{V}$	4.75		5.25	V
		$7.0\text{V} \leq V_I \leq V_{\text{Max}}$	4.75		5.25	
I_Q	Quiescent Current			2.0	5.5	mA
ΔI_Q	Quiescent Current Change	With Line	$8.0\text{V} \leq V_I \leq 20\text{V}$		1.5	mA
		With Load	$1.0\text{ mA} \leq I_O \leq 40\text{ mA}$		0.1	
N_O	Noise	$T_A = 25^{\circ}\text{C}$, $10\text{ Hz} \leq f \leq 100\text{ kHz}$		40		μV
$\Delta V_I / \Delta V_O$	Ripple Rejection	$f = 120\text{ Hz}$, $8.0\text{V} \leq V_I \leq 18\text{V}$, $T_J = 25^{\circ}\text{C}$	41	49		dB
V_{DO}	Dropout Voltage	$T_J = 25^{\circ}\text{C}$		1.7		V
$I_{\text{pk}} / I_{\text{OS}}$	Peak Output/Output Short Circuit Current	$T_J = 25^{\circ}\text{C}$		140		mA
$\Delta V_O / \Delta T$	Average Temperature Coefficient of Output Voltage	$I_O = 5.0\text{ mA}$		-0.65		$\text{mV}/^{\circ}\text{C}$

Note 1: The maximum steady state usable output current and input voltage are very dependent on the heat sinking and/or lead length of the package. The data above represent pulse test conditions with junction temperatures as indicated at the initiation of tests.

Note 2: Power Dissipation $\leq 0.75\text{W}$.

LM78L62AC

Electrical Characteristics

$0^{\circ}\text{C} \leq T_A \leq +125^{\circ}\text{C}$, $V_I = 12\text{V}$, $I_O = 40\text{ mA}$, $C_I = 0.33\ \mu\text{F}$, $C_O = 0.1\ \mu\text{F}$, unless otherwise specified (Note 1)

Symbol	Parameter	Conditions	Min	Typ	Max	Units	
V_O	Output Voltage	$T_J = 25^{\circ}\text{C}$	5.95	6.2	6.45	V	
$V_{R\text{ LINE}}$	Line Regulation	$T_J = 25^{\circ}\text{C}$	$8.5\text{V} \leq V_I \leq 20\text{V}$		65	175	mV
			$9.0\text{V} \leq V_I \leq 20\text{V}$		55	125	
$V_{R\text{ LOAD}}$	Load Regulation	$T_J = 25^{\circ}\text{C}$	$1.0\text{ mA} \leq I_O \leq 100\text{ mA}$		13	80	mV
			$1.0\text{ mA} \leq I_O \leq 40\text{ mA}$		6.0	40	
V_O	Output Voltage (Note 2)	$8.5\text{V} \leq V_I \leq 20\text{V}$	$1.0\text{ mA} \leq I_O \leq 40\text{ mA}$	5.90		6.5	V
		$8.5\text{V} \leq V_I \leq V_{\text{Max}}$	$1.0\text{ mA} \leq I_O \leq 70\text{ mA}$	5.90		6.5	
I_Q	Quiescent Current			2.0	5.5	mA	
ΔI_Q	Quiescent Current Change	With Line	$8.0\text{V} \leq V_I \leq 20\text{V}$			1.5	mA
		With Load	$1.0\text{ mA} \leq I_O \leq 40\text{ mA}$			0.1	
N_O	Noise	$T_A = 25^{\circ}\text{C}$, $10\text{ Hz} \leq f \leq 100\text{ kHz}$		50		μV	
$\Delta V_I / \Delta V_O$	Ripple Rejection	$f = 120\text{ Hz}$, $10\text{V} \leq V_I \leq 20\text{V}$, $T_J = 25^{\circ}\text{C}$	40	46		dB	
V_{DO}	Dropout Voltage	$T_J = 25^{\circ}\text{C}$		1.7		V	
$I_{\text{pk}} / I_{\text{OS}}$	Peak Output/Output Short Circuit Current	$T_J = 25^{\circ}\text{C}$		140		mA	
$\Delta V_O / \Delta T$	Average Temperature Coefficient of Output Voltage	$I_O = 5.0\text{ mA}$		-0.75		mV/ $^{\circ}\text{C}$	

LM78L82AC

Electrical Characteristics

$0^{\circ}\text{C} \leq T_A \leq +125^{\circ}\text{C}$, $V_I = 14\text{V}$, $I_O = 40\text{ mA}$, $C_I = 0.33\ \mu\text{F}$, $C_O = 0.1\ \mu\text{F}$, unless otherwise specified (Note 1)

Symbol	Parameter	Conditions	Min	Typ	Max	Units	
V_O	Output Voltage	$T_J = 25^{\circ}\text{C}$	7.87	8.2	8.53	V	
$V_{R\text{ LINE}}$	Line Regulation	$T_J = 25^{\circ}\text{C}$	$11\text{V} \leq V_I \leq 23\text{V}$		80	175	mV
			$12\text{V} \leq V_I \leq 23\text{V}$		70	125	
$V_{R\text{ LOAD}}$	Load Regulation	$T_J = 25^{\circ}\text{C}$	$1.0\text{ mA} \leq I_O \leq 100\text{ mA}$		15	80	mA
			$1.0\text{ mA} \leq I_O \leq 40\text{ mA}$		8.0	40	
V_O	Output Voltage (Note 2)	$11\text{V} \leq V_I \leq 23\text{V}$	$1.0\text{ mA} \leq I_O \leq 40\text{ mA}$	7.8		8.5	V
		$11\text{V} \leq V_I \leq V_{\text{Max}}$	$1.0\text{ mA} \leq I_O \leq 70\text{ mA}$	7.8		8.6	
I_Q	Quiescent Current			2.1	5.5	mA	
ΔI_Q	Quiescent Current Change	With Line	$12\text{V} \leq V_I \leq 23\text{V}$			1.5	mA
		With Load	$1.0\text{ mA} \leq I_O \leq 40\text{ mA}$			0.1	
N_O	Noise	$T_A = 25^{\circ}\text{C}$, $10\text{ Hz} \leq f \leq 100\text{ kHz}$		60		μV	
$\Delta V_I / \Delta V_O$	Ripple Rejection	$f = 120\text{ Hz}$, $12\text{V} \leq V_I \leq 22\text{V}$, $T_J = 25^{\circ}\text{C}$	39	45		dB	
V_{DO}	Dropout Voltage	$T_J = 25^{\circ}\text{C}$		1.7		V	
$I_{\text{pk}} / I_{\text{OS}}$	Peak Output/Output Short Circuit Current	$T_J = 25^{\circ}\text{C}$		140		mA	
$\Delta V_O / \Delta T$	Average Temperature Coefficient of Output Voltage	$I_O = 5.0\text{ mA}$		-0.8		mV/ $^{\circ}\text{C}$	

Note 1: The maximum steady state usable output current and input voltage are very dependent on the heat sinking and/or lead length of the package. The data above represent pulse test conditions with junction temperatures as indicated at the initiation of tests.

Note 2: Power Dissipation $\leq 0.75\text{W}$.

LM78L09AC

Electrical Characteristics

$0^{\circ}\text{C} \leq T_A \leq +125^{\circ}\text{C}$, $V_I = 15\text{V}$, $I_O = 40\text{ mA}$, $C_I = 0.33\ \mu\text{F}$, $C_O = 0.1\ \mu\text{F}$, unless otherwise specified (Note 1)

Symbol	Parameter		Conditions	Min	Typ	Max	Units
V_O	Output Voltage		$T_J = 25^{\circ}\text{C}$	8.64	9.0	9.36	V
$V_{R\text{ LINE}}$	Line Regulation		$T_J = 25^{\circ}\text{C}$	$11.5\text{V} \leq V_I \leq 24\text{V}$	90	200	mV
				$13\text{V} \leq V_I \leq 24\text{V}$	100	150	
$V_{R\text{ LOAD}}$	Load Regulation		$T_J = 25^{\circ}\text{C}$	$1.0\text{ mA} \leq I_O \leq 100\text{ mA}$	20	90	mV
				$1.0\text{ mA} \leq I_O \leq 40\text{ mA}$	10	45	
V_O	Output Voltage (Note 2)		$11.5\text{V} \leq V_I \leq 24\text{V}$	$1.0\text{ mA} \leq I_O \leq 40\text{ mA}$	8.55	9.45	V
			$11.5\text{V} \leq V_I \leq V_{\text{Max}}$	$1.0\text{ mA} \leq I_O \leq 70\text{ mA}$	8.55	9.45	
I_Q	Quiescent Current				2.1	5.5	mA
ΔI_Q	Quiescent Current Change	With Line	$11.5\text{V} \leq V_I \leq 24\text{V}$			1.5	mA
		With Load	$1.0\text{ mA} \leq I_O \leq 40\text{ mA}$			0.1	
N_O	Noise		$T_A = 25^{\circ}\text{C}$, $10\text{ Hz} \leq f \leq 100\text{ kHz}$		70		μV
$\Delta V_I / \Delta V_O$	Ripple Rejection		$f = 120\text{ Hz}$, $15\text{V} \leq V_I \leq 25\text{V}$, $T_J = 25^{\circ}\text{C}$	38	44		dB
V_{DO}	Dropout Voltage		$T_J = 25^{\circ}\text{C}$		1.7		V
$I_{\text{pk}} / I_{\text{OS}}$	Peak Output/Output Short Circuit Current		$T_J = 25^{\circ}\text{C}$		140		mA
$\Delta V_O / \Delta T$	Average Temperature Coefficient of Output Voltage		$I_O = 5.0\text{ mA}$		-0.9		$\text{mV}/^{\circ}\text{C}$

LM78L12AC

Electrical Characteristics

$0^{\circ}\text{C} \leq T_A \leq +125^{\circ}\text{C}$, $V_I = 19\text{V}$, $I_O = 40\text{ mA}$, $C_I = 0.33\ \mu\text{F}$, $C_O = 0.1\ \mu\text{F}$, unless otherwise specified (Note 1)

Symbol	Parameter		Conditions	Min	Typ	Max	Units
V_O	Output Voltage		$T_J = 25^{\circ}\text{C}$	11.5	12	12.5	V
$V_{R\text{ LINE}}$	Line Regulation		$T_J = 25^{\circ}\text{C}$	$14.5\text{V} \leq V_I \leq 27\text{V}$	120	250	mV
				$16\text{V} \leq V_I \leq 27\text{V}$	100	200	
$V_{R\text{ LOAD}}$	Load Regulation		$T_J = 25^{\circ}\text{C}$	$1.0\text{ mA} \leq I_O \leq 100\text{ mA}$	20	100	mV
				$1.0\text{ mA} \leq I_O \leq 40\text{ mA}$	10	50	
V_O	Output Voltage (Note 2)		$14.5\text{V} \leq V_I \leq 27\text{V}$	$1.0\text{ mA} \leq I_O \leq 40\text{ mA}$	11.4	12.6	V
			$14.5\text{V} \leq V_I \leq V_{\text{Max}}$	$1.0\text{ mA} \leq I_O \leq 70\text{ mA}$	11.4	12.6	
I_Q	Quiescent Current				2.1	5.5	mA
ΔI_Q	Quiescent Current Change	With Line	$16\text{V} \leq V_I \leq 27\text{V}$			1.5	mA
		With Load	$1.0\text{ mA} \leq I_O \leq 40\text{ mA}$			0.1	
N_O	Noise		$T_A = 25^{\circ}\text{C}$, $10\text{ Hz} \leq f \leq 100\text{ kHz}$		80		μV
$\Delta V_I / \Delta V_O$	Ripple Rejection		$f = 120\text{ Hz}$, $15\text{V} \leq V_I \leq 25\text{V}$, $T_J = 25^{\circ}\text{C}$	37	42		dB
V_{DO}	Dropout Voltage		$T_J = 25^{\circ}\text{C}$		1.7		V
$I_{\text{pk}} / I_{\text{OS}}$	Peak Output/Output Short Circuit Current		$T_J = 25^{\circ}\text{C}$		140		mA
$\Delta V_O / \Delta T$	Average Temperature Coefficient of Output Voltage		$I_O = 5.0\text{ mA}$		-1.0		$\text{mV}/^{\circ}\text{C}$

Note 1: The maximum steady state usable output current and input voltage are very dependent on the heat sinking and/or lead length of the package. The data above represent pulse test conditions with junction temperatures as indicated at the initiation of tests.

Note 2: Power Dissipation $\leq 0.75\text{W}$.

LM78L15AC

Electrical Characteristics

$0^{\circ}\text{C} \leq T_A \leq +125^{\circ}\text{C}$, $V_I = 23\text{V}$, $I_O = 40\text{ mA}$, $C_I = 0.33\ \mu\text{F}$, $C_O = 0.1\ \mu\text{F}$, unless otherwise specified (Note 1)

Symbol	Parameter	Conditions	Min	Typ	Max	Units	
V_O	Output Voltage	$T_J = 25^{\circ}\text{C}$	14.4	15	15.6	V	
$V_{R\text{ LINE}}$	Line Regulation	$T_J = 25^{\circ}\text{C}$	$17.5\text{V} \leq V_I \leq 30\text{V}$		130	300	mV
			$20\text{V} \leq V_I \leq 30\text{V}$		110	250	
$V_{R\text{ LOAD}}$	Load Regulation	$T_J = 25^{\circ}\text{C}$	$1.0\text{ mA} \leq I_O \leq 100\text{ mA}$		25	150	mV
			$1.0\text{ mA} \leq I_O \leq 40\text{ mA}$		12	75	
V_O	Output Voltage (Note 2)	$17.5\text{V} \leq V_I \leq 30\text{V}$	$1.0\text{ mA} \leq I_O \leq 40\text{ mA}$	14.25		15.75	V
		$17.5\text{V} \leq V_I \leq V_{\text{Max}}$	$1.0\text{ mA} \leq I_O \leq 70\text{ mA}$	14.25		15.75	
I_Q	Quiescent Current			2.2	5.5	mA	
ΔI_Q	Quiescent Current Change	With Line	$20\text{V} \leq V_I \leq 30\text{V}$			1.5	mA
		With Load	$1.0\text{ mA} \leq I_O \leq 40\text{ mA}$			0.1	
N_O	Noise	$T_A = 25^{\circ}\text{C}$, $10\text{ Hz} \leq f \leq 100\text{ kHz}$		90		μV	
$\Delta V_I / \Delta V_O$	Ripple Rejection	$f = 120\text{ Hz}$, $18.5\text{V} \leq V_I \leq 28.5\text{V}$, $T_J = 25^{\circ}\text{C}$	34	39		dB	
V_{DO}	Dropout Voltage	$T_J = 25^{\circ}\text{C}$		1.7		V	
I_{pk} / I_{OS}	Peak Output/Output Short Circuit Current	$T_J = 25^{\circ}\text{C}$		140		mA	
$\Delta V_O / \Delta T$	Average Temperature Coefficient of Output Voltage	$I_O = 5.0\text{ mA}$		-1.3		$\text{mV}/^{\circ}\text{C}$	

Note 1: The maximum steady state usable output current and input voltage are very dependent on the heat sinking and/or lead length of the package. The data above represent pulse test conditions with junction temperatures as indicated at the initiation of tests.

Note 2: Power Dissipation $\leq 0.75\text{W}$.

Equivalent Circuit

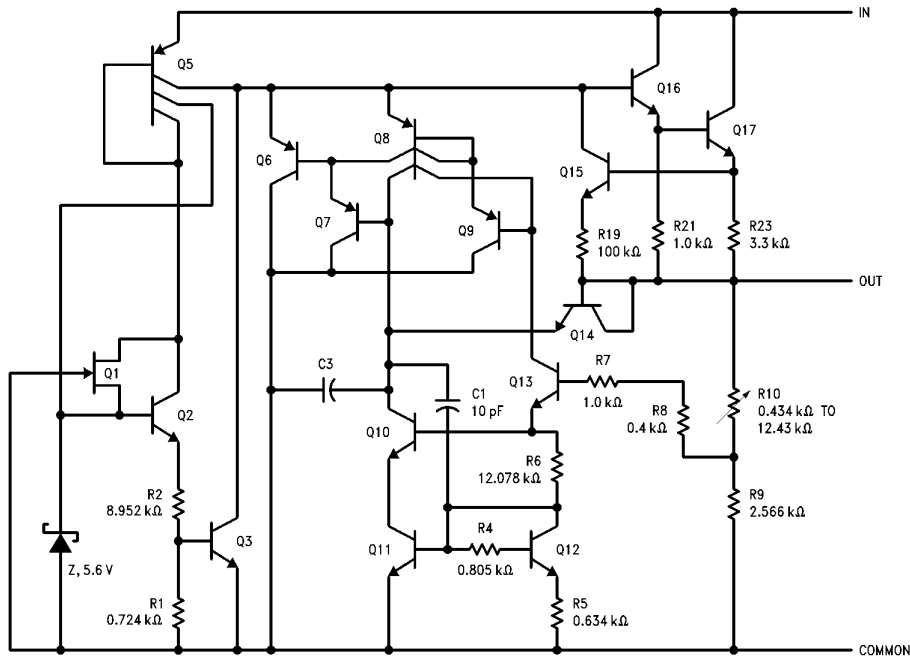

TL/H/10051-2

Typical Performance Characteristics

Worst Case Power Dissipation vs Ambient Temperature (TO-92)

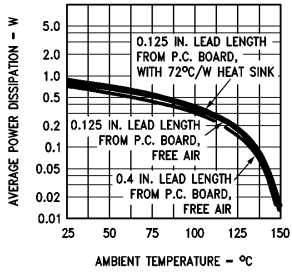

Dropout Voltage vs Junction Temperature

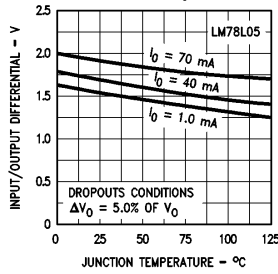

Dropout Characteristics

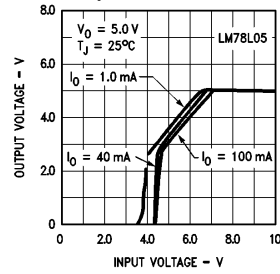

Quiescent Current vs Input Voltage

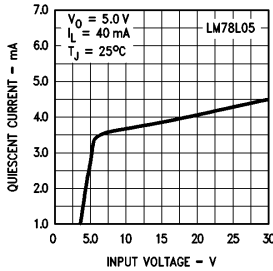

Quiescent Current vs Temperature

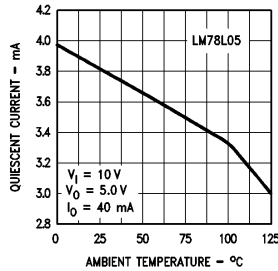

Ripple Rejection vs Frequency

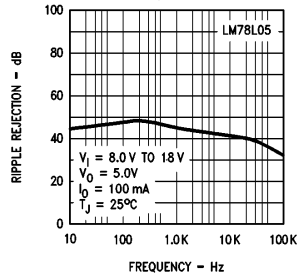

Line Transient Response

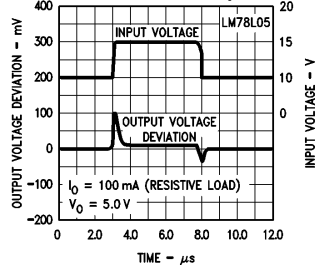

Load Transient Response

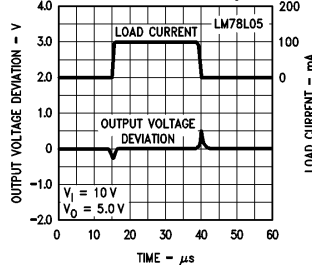

Note: Other LM78L00 Series devices have similar curves.

TL/H/10051-3

Design Considerations

The LM78L series regulators have thermal overload protection from excessive power, internal short-circuit protection which limits each circuit's maximum current, and output transistor safe-area protection for reducing the output current as the voltage across each pass transistor is increased.

Although the internal power dissipation is limited, the junction temperature must be kept below the maximum specified temperature (125°C) in order to meet data sheet specifications. To calculate the maximum junction temperature or heat sink required, the following thermal resistance values should be used:

Package	Typ θ_{JC}	Max θ_{JC}	Typ θ_{JA}	Max θ_{JA}
TO-92			160	160

Thermal Considerations

The TO-92 molded package is capable of unusually high power dissipation due to the lead frame design. However, its thermal capabilities are generally overlooked because of a lack of understanding of the thermal paths from the semiconductor junction to ambient temperature. While thermal resistance is normally specified for the device mounted 1 cm above an infinite heat sink, very little has been mentioned of the options available to improve on the conservatively rated thermal capability.

An explanation of the thermal paths of the TO-92 will allow the designer to determine the thermal stress he is applying in any given application.

The TO-92 Package

The TO-92 package thermal paths are complex. In addition to the path through the molding compound to ambient temperature, there is another path through the leads, in parallel with the case path, to ambient temperature, as shown in *Figure 1*.

The total thermal resistance in this model is then:

$$\theta_{JA} = \frac{(\theta_{JC} + \theta_{CA})(\theta_{JL} + \theta_{LA})}{\theta_{JC} + \theta_{CA} + \theta_{JL} + \theta_{LA}} \quad (1)$$

Where:

θ_{JC} = thermal resistance of the case between the regulator die and a point on the case directly above the die location.

θ_{CA} = thermal resistance between the case and air at ambient temperature.

θ_{JL} = thermal resistance from regulator die through the input lead to a point $\frac{1}{16}$ inch below the regulator case.

θ_{LA} = total thermal resistance of the input/output ground leads to ambient temperature.

θ_{JA} = junction to ambient thermal resistance.

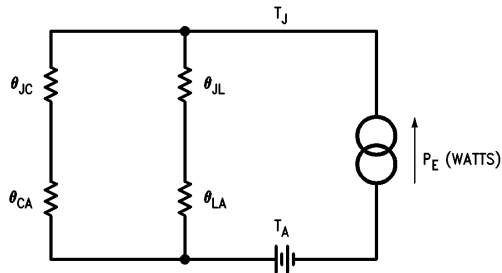

TL/H/10051-4

FIGURE 1. TO-92 Thermal Equivalent Circuit

Methods of Heat Sinking

With two external thermal resistances in each leg of a parallel network available to the circuit designer as variables, he can choose the method of heat sinking most applicable to his particular situation. To demonstrate, consider the effect of placing a small 72 °C/W flag type heat sink, such as the Staver F1-7D-2, on the LM78L00 molded case. The heat sink effectively replaces the θ_{CA} (*Figure 2*) and the new thermal resistance, θ'_{JA} , equals 145 °C/W (assuming, 0.125 inch lead length).

The net change of 15 °C/W increases the allowable power dissipation to 0.86W with a minimal inserted cost. A still further decrease in θ_{JA} could be achieved by using a heat sink rated at 46 °C/W, such as the Staver FS-7A. Also, if the case sinking does not provide an adequate reduction in total θ_{JA} , the other external thermal resistance, θ_{LA} , may be reduced by shortening the lead length from package base to mounting medium. However, one point must be kept in mind. The lead thermal path includes a thermal resistance, θ_{SA} , from the leads at the mounting point to ambient, that is, the mounting medium. θ_{LA} is then equal to $\theta_{LS} + \theta_{SA}$. The new model is shown in *Figure 2*.

In the case of a socket, θ_{SA} could be as high as 270 °C/W, thus causing a net increase in θ_{JA} and a consequent decrease in the maximum dissipation capability. Shortening the lead length may return the net θ_{JA} to the original value, but lead sinking would not be accomplished.

In those cases where the regulator is inserted into a copper clad printed circuit board, it is advantageous to have a maximum area of copper at the entry points of the leads. While it would be desirable to rigorously define the effect of PC board copper, the real world variables are too great to allow anything more than a few general observations.

Methods of Heat Sinking (Continued)

The best analogy for PC board copper is to compare it with parallel resistors. Beyond some point, additional resistors are not significantly effective; beyond some point, additional copper area is not effective.

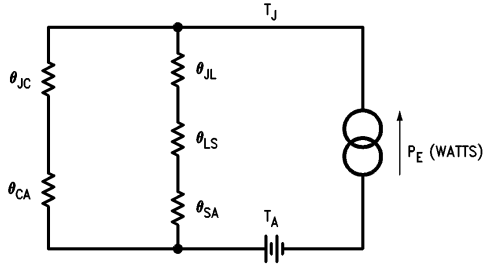

TL/H/10051-5

FIGURE 2. TO-92 Thermal Equivalent Circuit (Lead at other than Ambient Temperature)

High Dissipation Applications

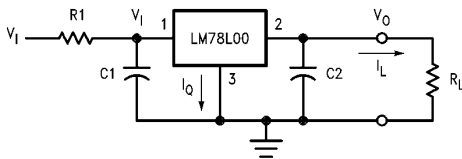

TL/H/10051-6

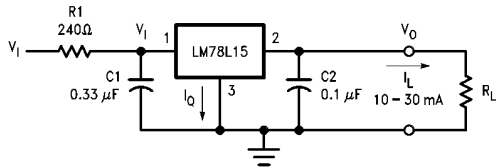

TL/H/10051-7

Where it is necessary to operate a LM78L00 regulator with a large input/output differential voltage, the addition of series resistor R1 will extend the output current range of the device by sharing the total power dissipation between R1 and the regulator.

$$R1 = \frac{V_{I \text{ Min}} - V_O - 2.0V}{I_{L \text{ Max}} + I_Q} \quad (2)$$

where:

I_Q is the regulator quiescent current.

Regulator power dissipation at maximum input voltage and maximum load current is now

$$P_{D \text{ Max}} = (V_1 - V_O) I_{L \text{ Max}} + V_1 I_Q \quad (3)$$

where:

$$V_1 = V_{I \text{ Max}} - (I_{L \text{ Max}} + I_Q) R1$$

The presence of R1 will affect load regulation according to the equation:

$$\begin{aligned} \text{Load regulation (at constant } V_1) &= \text{load regulation (at constant } V_1) \\ &+ \text{line regulation (mV per V)} \\ &\times (R1) \times (\Delta I_L). \end{aligned} \quad (4)$$

As an example, consider a 15V regulator with a supply voltage of $30 \pm 5.0V$, required to supply a maximum load current of 30 mA. I_Q is 4.3 mA, and minimum load current is to be 10 mA.

$$R1 = \frac{25 - 15 - 2}{30 + 4.3} = \frac{8}{34.3} \approx 240\Omega \quad (5)$$

$$V_1 = 35 - (30 + 4.3) 0.24 = 35 - 8.2 = 26.8V$$

$$\begin{aligned} P_{D \text{ Max}} &= (26.8 - 15) 30 + 26.8 (4.3) \\ &= 354 + 115 \end{aligned}$$

= 470 mW, which permit operation up to 70°C in most applications.

Line regulation of this circuit is typically 110 mV for an input range of 25V–35V at a constant load current; i.e. 11 mV/V.

$$\begin{aligned} \text{Load regulation} &= \text{constant } V_1 \text{ load regulation} \\ &\text{(typically 10 mV, 10 mA–30 mA } I_L) \\ &+ (11 \text{ mV/V}) \times 0.24 \times 20 \text{ mA} \\ &\text{(typically 53 mV)} \\ &= 63 \text{ mV for a load current change of} \\ &20 \text{ mA at a constant } V_1 \text{ of 30V.} \end{aligned} \quad (6)$$

Typical Applications

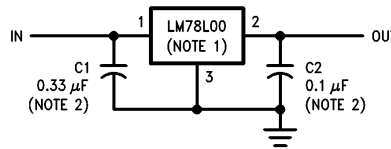

TL/H/10051-8

Note 1: To specify an output voltage, substitute voltage value for "00".

Note 2: Bypass capacitors are recommended for optimum stability and transient response and should be located as close as possible to the regulator.



Physical Dimensions inches (millimeters)

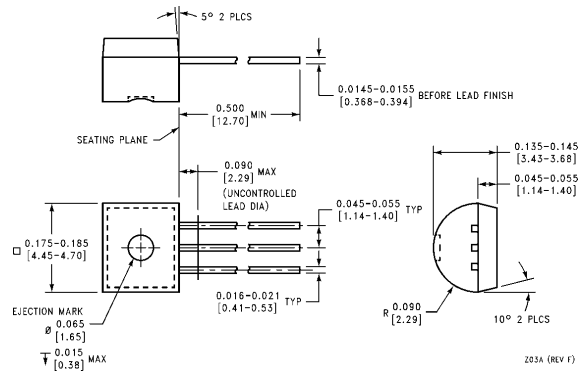

**Order Number LM78L05ACZ, LM78L09ACZ,
LM78L12ACZ, LM78L15ACZ, LM78L62ACZ or LM78L82ACZ
NS Package Number Z03A**

LIFE SUPPORT POLICY

NATIONAL'S PRODUCTS ARE NOT AUTHORIZED FOR USE AS CRITICAL COMPONENTS IN LIFE SUPPORT DEVICES OR SYSTEMS WITHOUT THE EXPRESS WRITTEN APPROVAL OF THE PRESIDENT OF NATIONAL SEMICONDUCTOR CORPORATION. As used herein:

1. Life support devices or systems are devices or systems which, (a) are intended for surgical implant into the body, or (b) support or sustain life, and whose failure to perform, when properly used in accordance with instructions for use provided in the labeling, can be reasonably expected to result in a significant injury to the user.
2. A critical component is any component of a life support device or system whose failure to perform can be reasonably expected to cause the failure of the life support device or system, or to affect its safety or effectiveness.



National Semiconductor Corporation
1111 West Bardin Road
Arlington, TX 76017
Tel: 1(800) 272-9959
Fax: 1(800) 737-7018

National Semiconductor Europe
Fax: (+49) 0-180-530 85 86
Email: cnjwge@tevm2.nsc.com
Deutsch Tel: (+49) 0-180-530 85 85
English Tel: (+49) 0-180-532 78 32
Français Tel: (+49) 0-180-532 93 58
Italiano Tel: (+49) 0-180-534 16 80

National Semiconductor Hong Kong Ltd.
19th Floor, Straight Block,
Ocean Centre, 5 Canton Rd.
Tsimshatsui, Kowloon
Hong Kong
Tel: (852) 2737-1600
Fax: (852) 2736-9960

National Semiconductor Japan Ltd.
Tel: 81-043-299-2309
Fax: 81-043-299-2408

National does not assume any responsibility for use of any circuitry described, no circuit patent licenses are implied and National reserves the right at any time without notice to change said circuitry and specifications.